

EDDYSTONE

Radio Products

Foreword

STRATTON & CO. LTD. have specialised in the manufacture of radio receivers and components, particularly for short waves, for more than twenty-five years, and the trade mark EDDYSTONE, featuring the famous lighthouse which bears the same name, is an assurance of fine workmanship, high reliability and enduring quality.

A comprehensive range of communications receivers is manufactured, covering wide frequency ranges, with models to suit practically all requirements. Following on the same lines and capable of superior performance, there are mains and battery broadcast models, designed essentially for arduous service overseas or on board ship. Separate literature describing these receivers is available on request.

EDDYSTONE products are available to the public through selected Distributors who hold good stocks and are in a position to give advice on the choice of components, accessories and receivers. A list of these Distributors can be supplied on request.

Direct enquiries are welcome from Government Departments and Manufacturers, and will receive prompt and courteous attention. Information on EDDYSTONE components in greater detail is available where necessary and consideration will always be given to minor modifications or variations, where the quantity involved justifies it.

All EDDYSTONE products are guaranteed for twelve months against faulty workmanship or defective material.

STRATTON & CO., LTD.

EDDYSTONE WORKS

ALVECHURCH ROAD . WEST HEATH . BIRMINGHAM, 31

Telephone : Priory 2231/4

Telegrams : Stratnoid, Birmingham

All EDDYSTONE variable capacitors are QUALITY APPROVED to R.C.S.141, Issue 2, Humidity Class H1, Temperature Category 40/100. R.C.S.C. Ref. Nos. are 1038/2 (1660) and 1022/1 (1660).

The range of transmitting variable condensers shown on these pages are of new design. They are mechanically well constructed and electrically are most efficient. The metal work is brass, the vanes are soldered to the supporting bars and the finish is matt silver plate. The single rotor contact obviates the possibility of loops and circulating current. Spindles are $\frac{1}{4}$ " diameter, and project $\frac{3}{16}$ " from the mounting face. Fixing parts (nuts, bolts, washers and distance pieces) are included. The condensers will withstand the voltages quoted, which are R.M.S. at 50 cycles, for one minute without flashing over.

The condensers illustrated on this and the facing page have double ceramic end plates, $2\frac{1}{2}$ " square, and double bearings. Details are given on opposite page.

For prices see separate list.

TRANSMITTING CONDENSERS

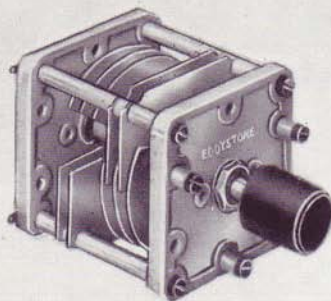

831

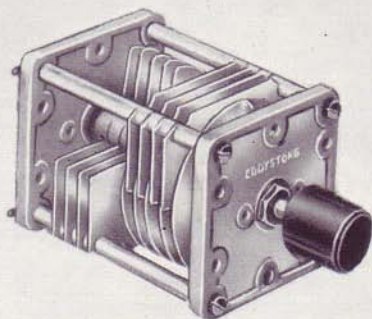

832

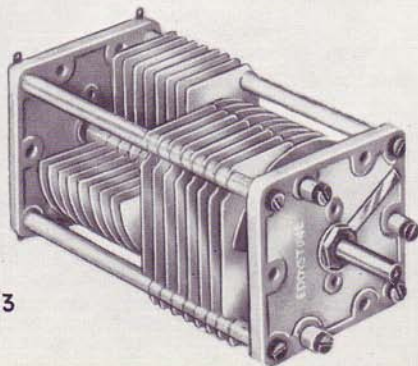

833

TRANSMITTING CONDENSERS

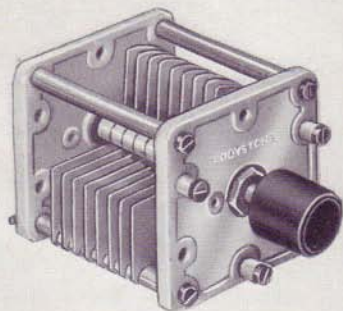

836

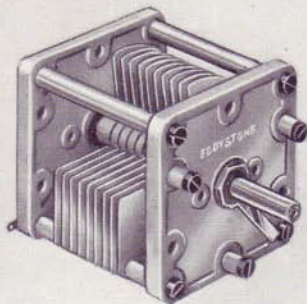

835

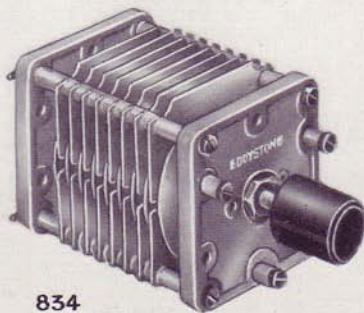

834

Single section transmitting condensers :

Cat. No. **835** 230 pF. maximum ; spacing
-040" ; 1250 volts.

Cat. No. **836** 100 pF. maximum ; spacing
-080" ; 2500 volts.

Split-stator condensers :

Cat. No. **831** 25 x 25 pF. maximum ; spacing
-080" ; 2500 volts per section.

Cat. No. **832** 50 x 50 pF. maximum ; spacing
-080" ; 2500 volts per section.

Cat. No. **833** 100 x 100 pF. maximum ; spacing
-080" ; 2500 volts per section.

Differential condenser :

Cat. No. **834** 100 x 100 pF. maximum ; spacing
-080" ; 2500 volts per section.

For prices see separate list.

TRANSMITTING CONDENSERS

The transmitting condensers shown here follow the same type of construction as those on the earlier pages. They utilise a single ceramic end plate 2" square and lend themselves to applications where space is limited. The three types listed are single section.

Cat. No. **815** 60 pF. maximum ; .048" spacing ; 1600 volts.

Cat. No. **816** 175 pF. maximum ; .024" spacing ; 1200 volts.

Cat. No. **817** 250 pF. maximum ; .024" spacing ; 1200 volts.

Heavy Duty Transmitting Condenser
Cat. No. 532 (not illustrated)

Strongly built with diecast end plates and frequentite insulation. The silver-plated brass vanes are rounded and polished, and soldered to the support bars. Single section, air gap 0.42", flashover voltage 9000 RMS, maximum capacity 150 pF. Measures 12 $\frac{1}{4}$ " long (excluding spindle), 8 $\frac{3}{8}$ " wide, 6 $\frac{7}{8}$ " high.

For prices see separate list.

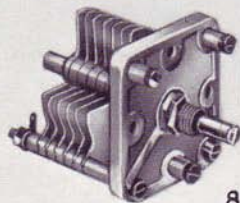

815

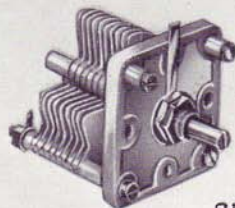

816

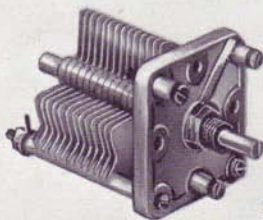

817

NEUTRALISING CONDENSERS



481



756

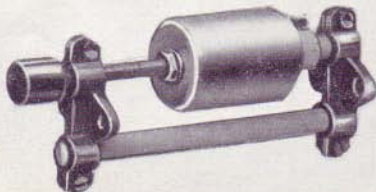

699

Small Neutralising Condenser Cat. No. 481

Linear capacity variation from 1.5 pF. minimum to 4 pF. maximum. Flashover voltage 2000 RMS at 50 cycles. Silver-plated brass parts on ceramic base, which mounts on chassis with a single 4 BA bolt.

Medium Neutralising Condenser Cat. No. 756

Disc type with silver-plated brass parts on a ceramic base, to which is fitted a ceramic stand-off insulator. Capacity variation 1.5 pF. to 8 pF. Flashover voltage at maximum capacity approximately 2000 RMS at 50 cycles and considerably greater at lower capacities.

Heavy Duty Neutralising Condenser Cat. No. 699

Designed for use with medium power triode transmitters. Ceramic insulation. Linear capacity variation from 3 pF. to 12 pF. Break-down voltage approximately 4500 RMS at 50 cycles. Overall height at minimum capacity setting 7½". Chassis mounting with two 4 BA bolts.

For prices see separate list.

MINIATURE & STANDARD MICRODENSERS

Miniature Microdensers

An entirely new range of miniature variable condensers, designed essentially for VHF applications, but having other uses also. The condensers utilise a single ceramic end plate, $\frac{3}{4}$ " square, and have .010" vane spacing. The spindle is $\frac{5}{32}$ " diameter, with a slot for screwdriver adjustment at both ends. The Cat. No. 550 Coupler, Cat. No. 878 Knob and Cat. No. 872 Slow Motion Dial are suitable for use with these Miniature Microdensers, which have soldered brass vanes and silver-plated finish.

Cat. No. 551 Butterfly, 25 × 25 pF. 90° rotation.

Cat. No. 552 Split-Stator 25 × 25 pF. 180° rotation.

Cat. No. 553 Single section 50 pF. 180° rotation.

Ceramic Microdensers

A comprehensive range of small variable condensers, well designed electrically and mechanically. The end plate is ceramic, $1\frac{5}{16}$ " square and the metal parts are silver-plated brass. The vanes are soldered to their supports. Spindle is $\frac{1}{4}$ " diameter, with screwdriver adjusting slot.

For prices see separate list.



551



553



552

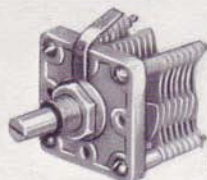

584

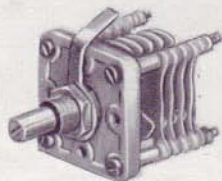

739

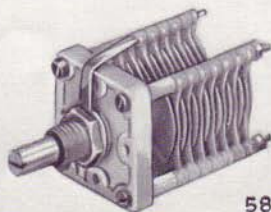

587

STANDARD MICRODENSERS

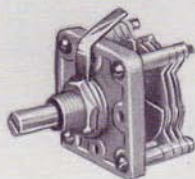

719

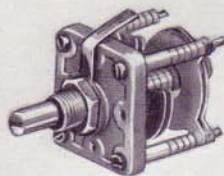

476

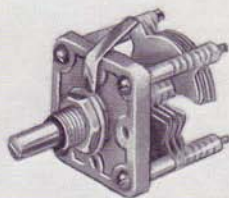

583

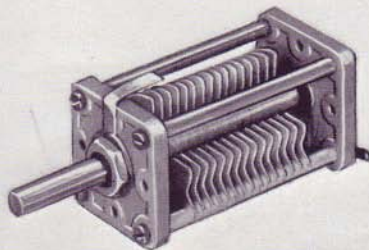

738

Butterfly types, 90° rotation for full capacity swing, single $\frac{3}{8}$ " hole mounting.

Cat. No. **584** 34 x 34 pF. Air gap .020".

Cat. No. **587** 15 x 15 pF. Air gap .052".

Cat. No. **739** 8 x 8 pF. Air gap .052".

Split-stator types, 180° rotation for full capacity swing, single $\frac{3}{8}$ " hole mounting.

Cat. No. **476** 15 x 15 pF. Air gap .020".

Cat. No. **583** 25 x 25 pF. Air gap .020".

Differential Condenser

Cat. No. **719** 25 x 25 pF. Air gap .020".

High stability Single Section Condenser
Double end plates and bearings. Three hole mounting (parts supplied).

Cat. No. **738** 100 pF. maximum. Air gap .030".

For prices see separate list.

STANDARD MICRODENSERS

All the **Ceramic Microdensers** shown on this page are **single ended types**. Cat. Nos. 580, 588 and 589 have wide vane spacings making them suitable for use in transmitting equipment.

Cat. No. 581 is a special type for screwdriver adjustment and is two hole fixing, with parts supplied. The other condensers are standard single $\frac{3}{8}$ " hole mounting.

Cat. No. **580** 12.5 pF. Air gap .062".

Cat. No. **581** 60 pF. Air gap .020".

Cat. No. **582** 60 pF. Air gap .020".

Cat. No. **585** 100 pF. Air gap .015".

Cat. No. **586** 140 pF. Air gap .015".

Cat. No. **588** 27.5 pF. Air gap .052".

Cat. No. **589** 54 pF. Air gap .030".

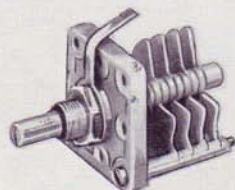

580

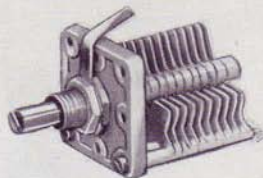

589

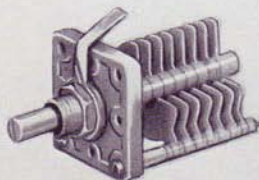

588

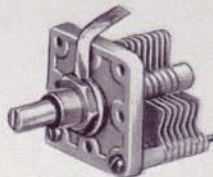

582

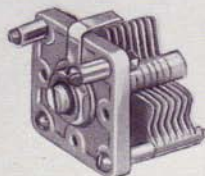

581

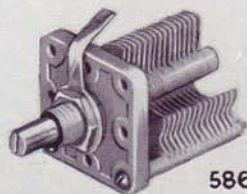

586

For prices see separate list.

R.F. CHOKES



1011



1010



737



1066



1022



776

Radio Frequency Chokes

A comprehensive range of R.F. chokes is available, and details are given below. All are wound on high grade bakelite formers and, with the exception of the Cat. No. 1066, have the patented "Eddystone" end connection, which provides a sound anchorage for the winding and obviates disturbance of the joint when mounting the choke. There is no metal end piece or shorted loop to degrade the performance. The chokes are wax impregnated and are suitable for use in tropical climates.

- Cat. No. **737** Inductance 2.5 millihenry, resistance 30 ohms, rated to carry 50mA.
 Cat. No. **776** Inductance 2.5 millihenry, resistance 19 ohms, to carry 250 mA.
 Cat. No. **1010** Inductance 1.25 millihenry, resistance 20 ohms, to carry 50 mA.
 Cat. No. **1011** Single layer, inductance 5.3 microhenry resistance 1.3 ohms, to carry 50 mA.
 Cat. No. **1022** Inductance 1.5 millihenry, resistance 10.5 ohms, to carry 250 mA.
 Cat. No. **1066** Inductance 13 millihenry, resistance 60 ohms, carries 50 mA, terminal connections, single hole mounting (6 BA screw).

Choke Formers

Moulded bakelite formers, with tinned lead-out wires held in the moulding.

- Cat. No. **864** Overall length $2\frac{1}{2}$ " Winding length 2", Diameter $\frac{1}{4}$ ".
 Cat. No. **865** Overall length $1\frac{11}{16}$ " Winding length $1\frac{1}{4}$ ", Diameter $\frac{1}{4}$ ".
 Cat. No. **866** Overall length 1" Winding length $\frac{11}{16}$ ", Diameter $\frac{1}{4}$ ".
 Cat. No. **867** Overall length 1" Winding length $\frac{1}{2}$ ", Diameter $\frac{3}{16}$ ".

For prices see separate list.

Plug-in Tuning Coils Cat. No. 706

A range of high quality, plug-in tuning coils, wound to close tolerances, and designed for modern valves and circuits. Three windings are provided and the coils are colour coded. Diameter is $\frac{7}{8}$ ", overall length $2\frac{1}{2}$ ". LB, Y and R types are wound on ribbed open formers. The others have adjustable dust-iron cores and protecting shields. Movement of the core will affect the average inductance value quoted.

Coil Type	Coverage with 140 pF. Condenser	Inductance of Tuned Winding
706/LB Blue	33—15 Mc/s.	·65 μ H.
706/Y Yellow	16—6·7 Mc/s.	3·45 μ H.
706/R Red	7·5—3·1 Mc/s.	17 μ H.
706/W White	3·3—1·35 Mc/s.	90 μ H.
706/P Pink	1·4 Mc/s.—720 kc/s.	300 μ H.
706/G Green	750—300 kc/s.	1·65 mH.
706/BR Brown	370—150 kc/s.	6·5 mH.

Coil Base Cat. No. 707

Of high grade insulating material, for use with Cat. No. 706 Coils. Two 6BA clearance holes for fixing, $1\frac{1}{16}$ " apart. Clearance hole $\frac{3}{8}$ ".

Coil Stand Cat. No. 775

Polished black bakelite with fixing holes. Accepts five spare Cat. No. 706 coils.

For prices see separate list.

COILS & BASES

781



706/P



765



706/LB



782

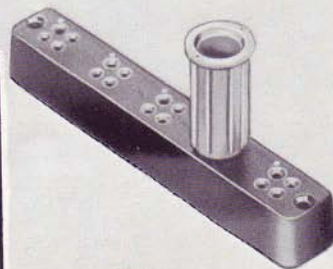
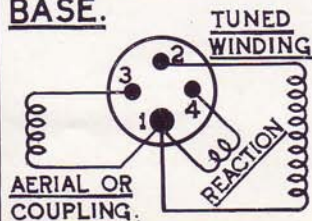

707

**UNDERSIDE OF
BASE.**

775

COIL FORMERS & BASES



648

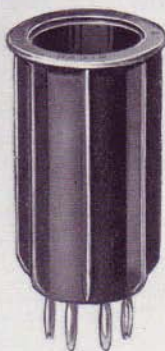

538



847



646



964

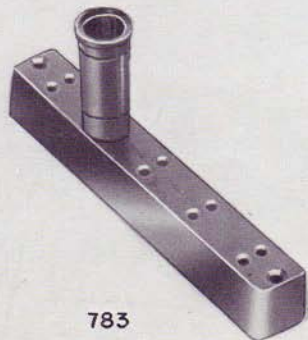

783

Coil Former Cat. No. 646

Plain ribbed former 1" diameter, $1\frac{7}{8}$ " long. High grade bakelite.

Coil Formers Cat. Nos. 647/648

Small bakelite former $1\frac{1}{2}$ " long, $\frac{5}{8}$ " diameter, fitted soldering tags. 647 is plain, 648 threaded 30 turns per inch.

Coil Formers Cat. Nos. 537/538

6 pin ribbed bakelite formers, outside diameter $1\frac{1}{2}$ ", winding length $2\frac{1}{2}$ ". 537 is plain, 538 threaded 14 turns per inch.

Coil Base Cat. No. 964

Chassis mounting bakelite base for Cat. Nos. 537/538 formers. Hole in chassis $1\frac{1}{4}$ ".

Coil Former Cat. No. 847

A small, ribbed, low-loss polystyrene former which has numerous applications in VHF and HF equipment. Diameter is $\frac{11}{16}$ " and available winding length $\frac{3}{4}$ ". Base flange measures $1\frac{1}{8}$ " x $\frac{1}{4}$ " and has two holes for fixing. Complete with special quality powdered-iron core and rubber string.

Miniature Plug-in Formers

Air core type only, as used in Cat. No. 706 coils. Fit Cat. No. 707 base.

Cat. No. 763 Plain former.

Cat. No. 765 Threaded former, 21 turns per inch.

Small 2 pin Formers

Plain black bakelite, $\frac{5}{8}$ " diameter suitable for wavemeter, wavetrap and other coils.

Cat. No. 781 Coil Former.

Cat. No. 782 2 pin Coil Base.

Cat. No. 783 Holds five spare Cat. No. 781 coils and is similar otherwise to Cat. No. 775.

For prices see separate list.

Full Vision Dial Cat. No. 598

The epicyclic, ball bearing drive mechanism is of improved design and has a reduction ratio of approximately 10 to 1. The movement is smooth and free from backlash. The dial escutcheon measures 6" long by $4\frac{1}{8}$ " wide plus a $\frac{3}{16}$ " lip. The scale is marked 0—100 over 180°, and is 5" across. A large fluted instrument knob is fitted. Ripple black finish.

Vernier Slow Motion Dial Cat. No. 843

Anodised satin finished hard aluminium dial, 4" diameter, with a scale having 100 divisions marked over 180°. Markings are in black and a vernier strip, finished to match, is provided. The driving head is of an improved ball-bearing epicyclic type, totally enclosed, and giving a reduction ratio of approximately 10 to 1. Physical details are: mounting hole $\frac{13}{16}$ " clearance with two 4 BA holes on $1\frac{1}{8}$ " pitch circle; spindle projection at rear $\frac{1}{4}$ " diameter by $\frac{1}{4}$ " long; projection in front of panel $1\frac{7}{32}$ ", rear $1\frac{9}{32}$ ".

For prices see separate list.

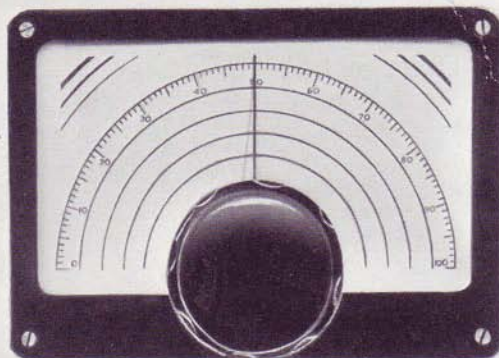
DIALS

598

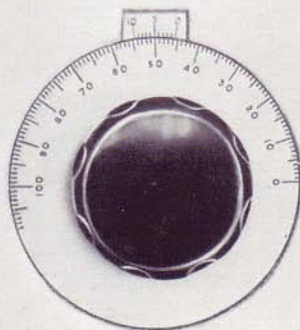

843

DIALS



62



425



842



844

Pointer Knob and Dial Cat. No. 62

Light metal scale, marked 100 divisions in black over 180°. Diameter is 3", central hole $\frac{1}{2}$ ", two 6 BA mounting holes. The knob is the Cat. No. 1027 described on Page 14.

Direct Drive Knob and Dial Cat. No. 844

Anodised satin finished hard aluminium dial, 2" diameter, securely fixed to a black bakelite fluted knob $1\frac{1}{8}$ " diameter. Scale markings, in black, are ten major divisions, covering 180° and numbered 1 to 10 anti-clockwise, and a further ten sub-divisions. Fits on to $\frac{1}{4}$ " diameter spindles. Index pillar to match provided.

Pointer Knob and Dial Cat. No. 842

Satin finished aluminium dial, $1\frac{3}{4}$ " diameter, marked in ten main divisions (reading 0 to 10 clockwise), and a further ten sub-divisions, over an arc of 265 degrees. Centre hole is $\frac{3}{8}$ " diameter to enable dial to be fixed beneath panel locking nut. The knob is the Cat. No. 841 described overleaf.

Miniature Slow Motion Dial Cat. No. 872

A precision slow motion dial of small size for special applications. Scale is anodised, satin-finished hard aluminium, $1\frac{1}{2}$ " diameter, with markings in black, 100 divisions graduated in tens, over 180°. The epicyclic ball-bearing head is enclosed in a $\frac{3}{8}$ " diameter brass housing, flanged for panel fitting. Mounts with three 8 BA bolts on a $27/32$ " pitch circle. Rear spindle projection $7/32$ " long, $5/32$ " diameter (fits Cat. No. 550 Coupler). Skirt knob $7/8$ " diameter fitted and an index pillar is supplied. Total projection behind panel $\frac{1}{8}$ ", in front $27/32$ ".

For prices see separate list.

All the knobs on this page are moulded in black bakelite, with a highly polished finish. All except Cat. No. 878 accept $\frac{1}{4}$ " diameter spindles.

Skirt Knobs

Cat. No. 786 Overall diameter $\frac{7}{8}$ ", depth $\frac{1}{2}$ ".

Cat. No. 878 As 786, but with brass insert and hole to take $\frac{5}{32}$ " spindle. Suitable for use with Miniature Microdensers on Page 6.

Cat. No. 2416P Overall diameter $1\frac{3}{4}$ ", depth $\frac{3}{8}$ ". Brass insert.

Cat. No. 875 Knob has eight flutes and is $1\frac{3}{8}$ " diameter; to it is screwed a skirt portion $1\frac{3}{4}$ " diameter. Overall depth $\frac{3}{4}$ ". Brass insert and two 4 BA grub screws.

Cat. No. 784 Overall diameter $3\frac{1}{4}$ ", depth $\frac{3}{4}$ ". Brass insert and two grub screws.

Pointer Knobs

Cat. No. 1027 $2\frac{1}{2}$ " long, indicator line filled white. Indicating radius $1\frac{3}{32}$ ". Recess for panel nut. 4 BA grub screw.

Cat. No. 841 Smooth plain sides. Overall length $1\frac{1}{2}$ ", width $\frac{3}{4}$ ", depth $\frac{9}{16}$ ", indicating radius $\frac{5}{8}$ ". White engraved line. 6 BA screw locking into trapped 6 BA nut.

For prices see separate list.

SKIRT & POINTER KNOBS



786
&
878



2416



875



784



1027



841

KNOBS



WITHDRAWN

785



593



846



WITHDRAWN

1089



592



WITHDRAWN

1076



877



591

High grade instrument knobs, moulded in black bakelite, with a highly polished finish. All accept $\frac{1}{4}$ " spindles.

Cat. No. **785** Long knob, $\frac{7}{8}$ " diameter, $\frac{11}{16}$ " deep. Recess to cover panel nut.

Cat. No. **1076** Fluted knob, $2\frac{1}{2}$ " diameter. Brass insert and two grub screws.

Cat. No. **1089** As Cat. No. 1076 but $1\frac{3}{8}$ " diameter.

Cat. No. **591** Fluted knob, brass insert, one grub screw, diameter $2\frac{1}{8}$ ".

Cat. No. **592** As Cat. No. 591, but diameter $1\frac{3}{8}$ ".

Cat. No. **593** As Cat. No. 591, but diameter $\frac{3}{4}$ ".

Cat. No. **846** Bar knob of tapered rectangular shape, for use where considerable torque is required. Brass insert, 2 BA steel grub screw. Length $1\frac{3}{4}$ ", width $\frac{3}{4}$ ", depth $\frac{3}{4}$ ".

Cat. No. **877** Wing knob, with two shaped ribs providing a firm grip. White indicating line on one rib. Brass insert. Diameter $\frac{7}{8}$ ", width across ribs $1\frac{3}{8}$ ", thickness $\frac{7}{8}$ ".

For prices see separate list.

Absorption Wavemeter Cat. No. 696/1

This instrument is housed in a diecast box, in the top of which is a socket to take a plug-in coil, chosen according to the particular frequency band in which a check is desired. Eight coils are supplied giving a continuous coverage from 200 kc/s. to 150 Mc/s. Individual hand calibrated charts are provided, with a containing tube, and two coil-stands are included to take coils not in use.

When used with a transmitter or oscillator, indication of resonance with the circuit under test is given by a reading on a 200 microampere moving coil meter, scaled off with linear graduations from 1 to 10. The combination of this meter with a Germanium Crystal Rectifier ensures excellent sensitivity.

In other cases, resonance is shown by the desensitising effect which occurs when the Wavemeter is coupled to and brought into resonance with the circuit under test.

Modulation Level Indicator Cat. No. 678

The circuit employs two germanium crystal rectifiers and no external connections are necessary. The small pick-up aerial provided screws into a socket on top and a socket takes a coil for the particular frequency band in use. In use the R.F. pick-up is adjusted until the meter reading coincides with a mark on the scale when, on switching over, modulation percentages can be read off instantly against the directly calibrated scale. In addition the instrument may be used as a 'phone monitor, a telephone jack being provided at the rear for this purpose. The meter itself is very sensitive (200 microamp. full scale deflection) which permits the instrument to be used as a field strength meter. It will assist materially in such experiments as lining up a beam aerial, determining radiation patterns, effect of variation of coupling and matching systems, etc. The calibration holds good over the whole range of amateur bands, up to 28 Mc/s. In neat diecast housing, finished black. Complete with 6 coils (21 Mc/s. is included).

For prices see separate list.

WAVEMETER & MODULATION METER

696/1

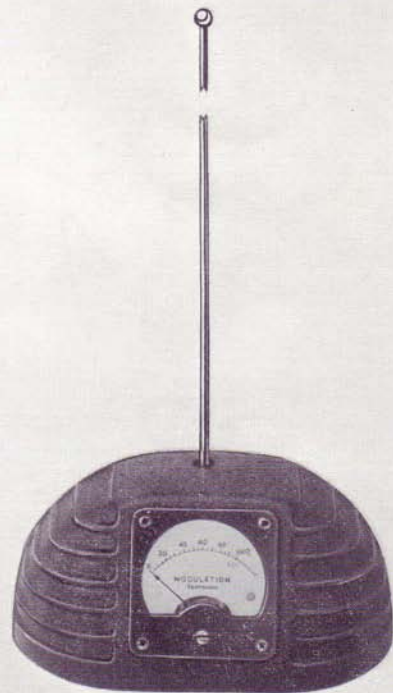
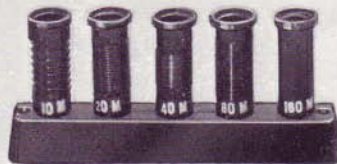

678

MORSE KEY & TRANSMITTING COIL-FORMER WITH BASE

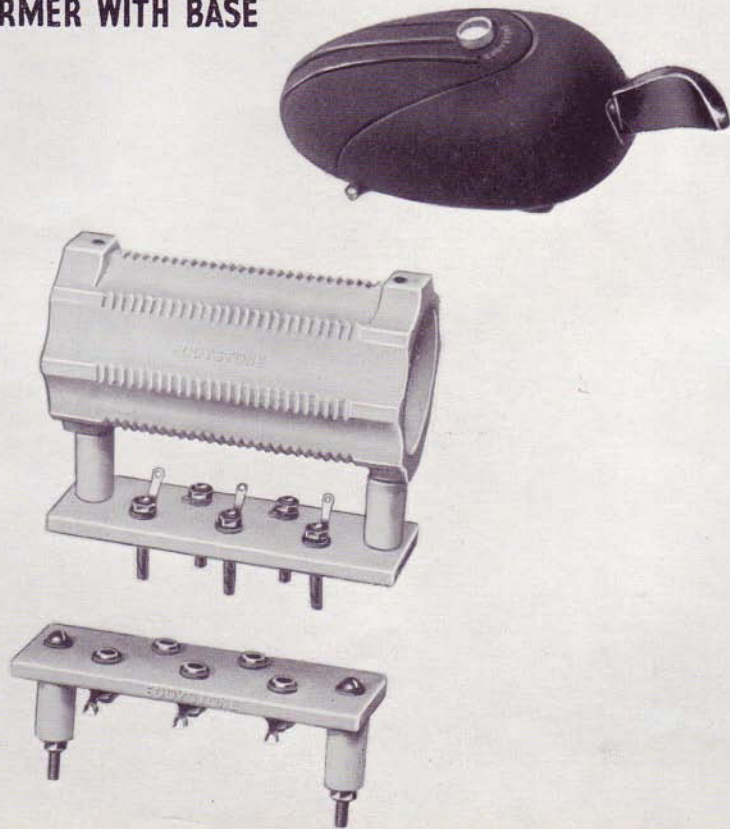

Semi-automatic Speed Key Cat. No. 689

This key, of really modern design, is totally enclosed in a streamlined diecast housing, which is finished a fine ripple black with chrome relief. The movement has received special attention and is a fine example of first class light engineering. Words cannot do justice to the beautiful action, you must try the key for yourself to appreciate it. It is fully adjustable to enable any operator to make full use of the wide range of speeds provided. The handle has been designed to give equal facility to right or left handed operators. A short-circuiting switch is fitted to the base, which is a heavy diecasting provided with rubber feet and with holes for screwing down.

Frequentite Coil Former Cat. No. 1090

This former is $2\frac{1}{2}$ " diameter and 5" long, and may be used separately or made up into a plug-in unit. Spiral grooves take 26 turns of wire, up to 12 S.W.G., whilst 14 holes are provided for leads and coil tapplings. The former is designed for use on frequencies of 3 Mc/s. upwards in transmitting or electronic apparatus.

Frequentite Sub-base Cat. No. 1091

This is easily and firmly attached to the former with the bolts, lead washers and pillars provided, or it can be used separately for a self-supporting inductance. Robust power type plugs ensure positive electrical contact. Soldering tags are heavy gauge tinned phosphor-bronze, self-locking.

Frequentite Base Cat. No. 1092

Similar to the Cat. No. 1091 sub-base, except that heavy duty power type sockets are fitted. Pillars, bolts and lead washers supplied, for chassis mounting.

For prices see separate list.

Aerial Strain Insulator Cat. No. 966

A highly efficient insulator for use in the construction of transmitting and receiving aerials. Pyrex glass, 3" long.

Heavy Duty Lead-through Insulator Cat. No. 794

Two borosilicate heat-resisting glass cones fit freely on to a plated brass rod, $\frac{1}{4}$ " diameter, $6\frac{1}{2}$ " long. The hollow cones are spigotted at the base to mount into a $1\frac{1}{8}$ " diameter hole, and wall thicknesses between $\frac{7}{16}$ " and $2\frac{7}{16}$ " can be accommodated. Wing nuts and washers are fitted at the ends of the rod. Flashover voltage greater than 10 kilovolts.

Low-loss Aerial Lead-in Insulator Cat. No. 946

The external part is of high grade vitreous porcelain, which withstands the weather and presents a long leakage path between the metal centre portion and earth. The tube is high tensile glass, $\frac{1}{2}$ " diameter, $5\frac{3}{4}$ " long (behind insulator). The metal parts are polished nickel plated brass, and wing nuts are fitted at both ends. A special moulded watertight rubber washer fitted inside the cone prevents breakage and takes up mounting errors.

For prices see separate list.

INSULATORS

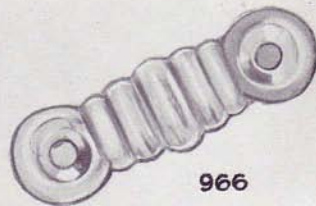

966

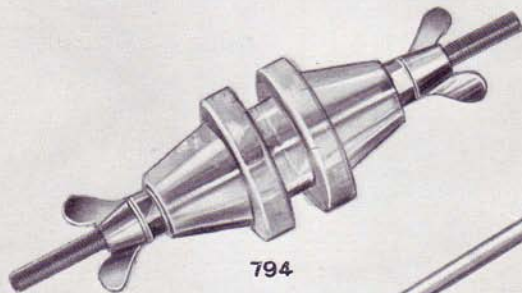

794

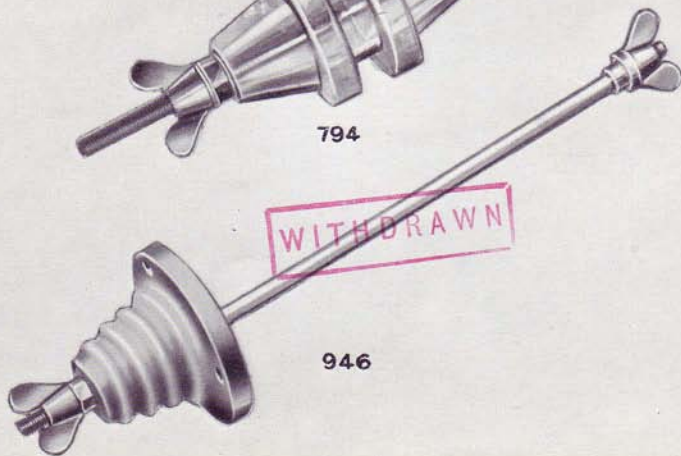

946

INSULATORS



565



695

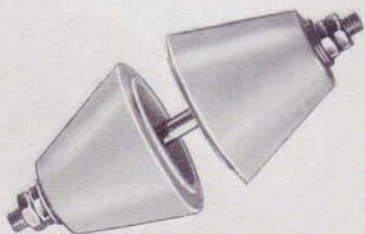

1018



1019



916

Moulded Insulator Cat. Nos. 564 and 565

This moulded insulator is very useful as "stand-off," "lead-through" or "terminal post." It is supplied in two colours: Red (Cat. No. 564) and Black (Cat. No. 565). The reversible fittings enable the insulator to be mounted above or through a chassis or panel. Construction is such that neither the centre bolt nor the insulator itself can revolve when tightening the 2 BA wire holding nuts. Satisfactory for 2000 volts working, $1\frac{1}{2}$ " high, $1\frac{1}{4}$ " between fixing holes.

Ceramic Lead-through Insulator Cat. No. 695

Of the bushed or spigotted type, with an overall length of $1\frac{1}{2}$ ". Nickel plated 4 BA centre piece. Fixing hole to clear $\frac{1}{16}$ ". Fibre washers supplied.

Ceramic Lead-through Insulator Cat. No. 1018

The insulating parts are glazed frequentite cones, each $1\frac{1}{8}$ " long, $1\frac{3}{8}$ " maximum diameter, flanged at the base to fit into a chassis or panel. Centre part is a nickel plated 2 BA brass rod, $3\frac{1}{2}$ " long. Lead washers supplied.

Miniature Insulator Cat. No. 1019

Midget frequentite insulator with plated brass parts. A useful accessory for short wave receivers and transmitters. Frequentite part $\frac{5}{8}$ " high, maximum width $\frac{1}{4}$ ".

Stand-off Insulator Cat. No. 916

This insulator has many applications in radio, electrical and electronic apparatus. It is ideal for mounting inductances, meters, spacing aerial feeders, and, in fact, for all insulating purposes where high voltages are met. Made from special quality white vitreous porcelain, glazed finish, with hollow centre. Metal parts are heavily nickel plated. Height $2\frac{3}{8}$ ", diameter of base $2\frac{1}{4}$ ".

For prices see separate list.

SPEAKERS, "S" METER, MOUNTING BLOCKS

Signal Strength Meter Cat. No. 669

Ideal for use with the "640," "740" and "750" Receivers. Neat diecast housing, finished a fine ripple black, with the necessary resistors, including the zero adjuster, fitted inside. The meter, which has a 200 microampere full scale deflection, is calibrated in "S" units and decibels above S9, on the basis of a 4 db increase in carrier strength for each "S" point. The leads terminate in an octal plug, which permits direct connection to the socket at the rear of the receiver.

Diecast Loudspeakers

This efficient speaker is recommended for use with Eddystone Communications receivers. A 5" diameter permanent magnet unit, of 3 ohms impedance, is housed in an alloy diecasting 7" in diameter, the absence of case resonance leading to an excellent performance. Complete with lead. Each model is identical except for the colours, which match those of the various receivers.

Cat. No. 688 — black ripple finish.

Cat. No. 697 — brown ripple finish.

Cat. No. 811 — polychromatic grey finish.

Receiver Mounting Blocks

Of diecast aluminium, these useful blocks lift up the front of a receiver and give a more convenient operating position. Held in place by weight of receiver or can be bolted to underside of cabinet. Approximate dimensions 6½" long and 2½" deep at front.

Cat. No. 774 — ripple black finish.

Cat. No. 812 — polychromatic grey finish.

811

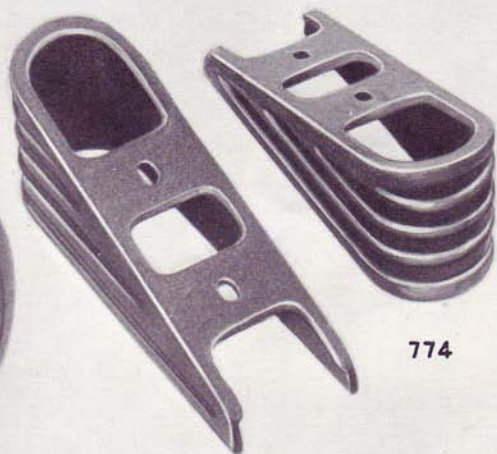

774

669



For prices see separate list.

FILTER & VIBRATOR UNITS



732

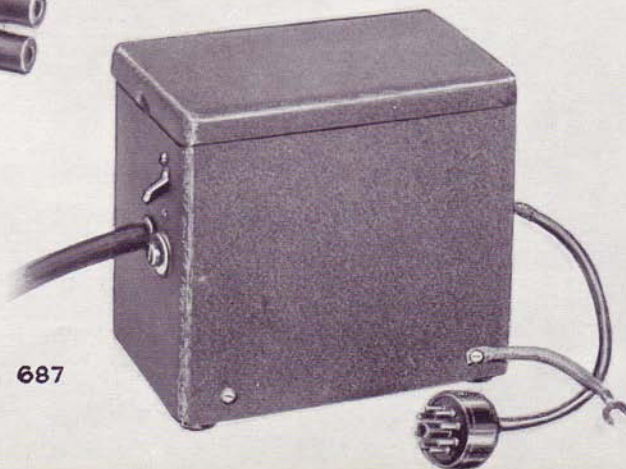

687

Mains Filter Unit Cat. No. 732

Interference caused by electrical machinery and apparatus can be considerably reduced, if not eliminated, by fitting a suitable filter unit. The Eddystone Mains Filter Unit has been designed specifically for this purpose and will be found most efficient. It takes the form of a small metal box, finished ripple brown, and is supplied with mains plug and socket. The unit takes but a few minutes to fit between the main supply point and the receiver. Rated to carry 0.5 amp. maximum.

Vibrator Power Unit Cat. No. 687

Designed to permit the operation of a receiver or other equipment (the HT consumption of which is not more than 65 mA) from a 6 volt accumulator. It is very suitable for use with the Eddystone "640" and "740" receivers. The unit comprises a transformer, non-synchronous vibrator, rectifier valve (6X5G) on/off switch, and the necessary filters to prevent R.F. interference. Smoothing is not included, since the choke and condensers fitted in the receiver perform this function. A heavy cable is provided for connection to the battery, and a lead, terminating in an octal plug, for fitting direct to the socket provided on the receiver in the case of models "640" and "740." The Unit is totally enclosed in a small metal cabinet, finished ripple black. The consumption from a 6-volt battery is between 5 and 6 amperes, dependent on load.

Vibrator Power Unit Cat. No. 687/1

Basically similar to the Cat. No. 687 but adapted for use with the "750" receiver, which has balanced heaters. Two octal plugs. Consumption approximately 7 amperes (with "750").

For prices see separate list.

EQUIPMENT CABINET AND RACK

Two major items — the rack assembly and the cabinet assembly — together make up into a modern type of rack equipment which has numerous applications. Mild steel is used throughout. All parts are rust-proofed and, with the exception of the chassis (which is plated), are finished plain grey stove enamel.

Details are as follows :

Three-way Equipment Rack Cat. No. 874 comprises two vertical channels, one bottom frame, and two tie bars. It is supplied unassembled, with the necessary nuts and screws. The dimensions are, height $22\frac{1}{2}$ " ; width $14\frac{1}{2}$ " ; depth 8". The vertical channels are drilled to take three cabinets Cat. No. 873, whilst the bottom frame is provided with four holes for bolting down if necessary.

Rack Mounting Cabinet Cat. No. 873 consists of the following items, supplied unassembled :

- 1 Panel (Cat. No. 861) 14" wide by $7\frac{1}{2}$ " high
- 1 Chassis (Cat. No. 862) 12" long, $5\frac{3}{8}$ " wide, 2" deep, plus flange $\frac{3}{8}$ ".
- 2 End Plates
- 1 Back Plate
- 2 Cover Plates
- 1 pair Handles (Cat. No. 635).

The panel has two $\frac{9}{32}$ " diameter holes on each side for fixing to the Cat. No. 862 Chassis with the Cat. No. 635 plated handles, and there are two further slotted holes on each side for rack mounting. Both chassis and panel are made of .048" mild steel. The complete cabinet assembly measures 14" wide, $7\frac{1}{2}$ " high, 6" deep. Spare panels and chassis can be supplied as separate items (see above).

For prices see separate list.

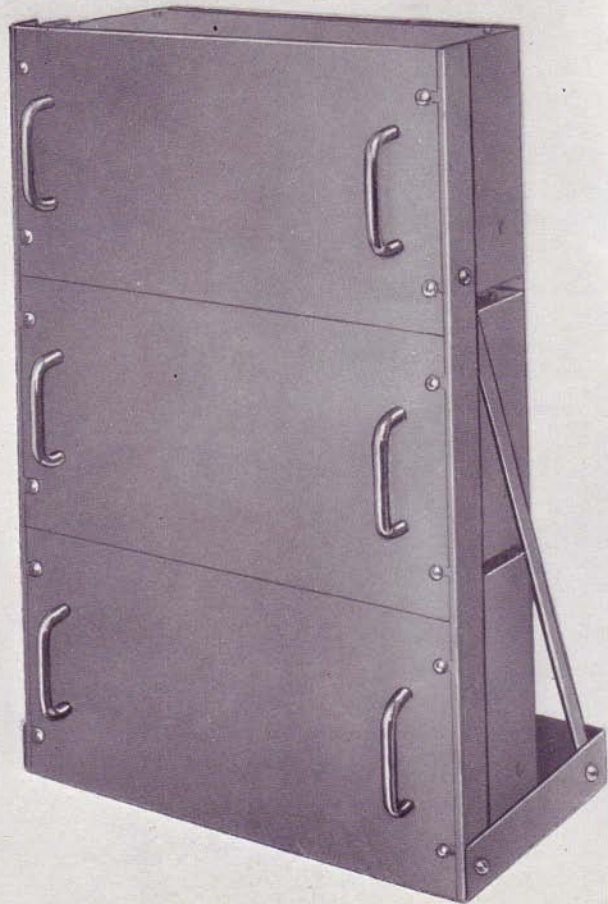

CABINETS

Metal Cabinet Cat. No. 644

Steel cabinet, of improved design, intended to house the Cat. No. 643 chassis. Handsomely finished in ripple black. Lift-up lid with catch, rear left open. Internal measurements: $10\frac{1}{2}'' \times 6'' \times 6\frac{15}{16}''$.

Cabinet Assembly Cat. No. 787

Of mild steel, measuring $16\frac{3}{4}''$ long, $8\frac{3}{4}''$ high and 9" from back to front, and ideal for the construction of equipment having a professional appearance. The cabinet is fitted with a hinged lid and has ventilating louvres in the sides, rear and top. External finish is fine ripple black, internal smooth black. A chassis to match is included and measures $16\frac{1}{2}''$ long, $7\frac{1}{4}''$ wide, 3" deep. It is fixed to the panel by means of special end plates to which also the cabinet is attached by four screws at the rear. The whole is supplied ready assembled. **Chassis** (without end plates) is available separately, as Cat. No. 788.

For prices see separate list.



787



644

I.F., B.F.O. & DISCRIMINATOR UNITS

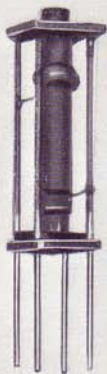

851



728



855

Intermediate Frequency and Discriminator Transformers and BFO Units

All the components in this range are of standard size, being enclosed in extruded aluminium screening cans $\frac{13}{16}$ " square and $2\frac{1}{2}$ " high. The lead-out wires are fixed to the square base of the coil-former which fits into the open end of the can. Two 6 BA tapped holes in the base, $\frac{13}{32}$ " apart, permit easy mounting. Permeability tuning is carried out by adjustment of the threaded powdered-iron cores, accessible from either end. Connections are indicated by markings on the can and base.

Cat. No. 851	455 kc/s. I.F. Transformer.
Cat. No. 852	455 kc/s. BFO Unit.
Cat. No. 853	5.2 Mc/s. I.F. Transformer.
Cat. No. 854	5.2 Mc/s. Discriminator Transformer.
Cat. No. 855	5.2 Mc/s. BFO Unit.
Cat. No. 856	10.7 Mc/s. I.F. Transformer.
Cat. No. 857	10.7 Mc/s. Discriminator Transformer.

I.F. Output Transformer Cat. No. 728

A special I.F. transformer for use with V.H.F. converters. It comprises one tuned winding (with adjustable iron core) and one low impedance output winding. This transformer ensures optimum transfer of energy from the converter to the associated receiver, the latter being tuned to a frequency near 10 Mc/s. Plated brass screening can.

For prices see separate list.

Flexible Couplers

Facilitate lining up variable condensers and other components. Completely flexible and free from backlash. Insulating material is white DL12, possessing excellent electrical and mechanical characteristics. The spring arms are phosphor-bronze. Nickel plated finish.

Cat. No. 50 1½" diameter, 1⅝" wide, accepts ¼" spindles.

Cat. No. 529 1⅜" diameter, 7⁄8" wide, accepts ¼" spindles.

Cat. No. 550 1⅜" diameter, 5⁄8" wide, accepts 3⁄8" spindles.

Flexible Driving Shaft Cat. No. 530

For front panel control of out-of-line components. Length is adjustable between 4½" and 6", and the drive is satisfactory through 45 degrees. Insulating part is frequotite. End accepts ¼" spindle.

Tools

Made of black bakelite. No. 122T has small steel tip to fit a screwdriver slot. No. 125T is for tightening the rings used for securing B9G type valves (e.g. EF50).

Cat. No. 122T Metal-tipped Trimming Tool.

Cat. No. 125T Valve Ring Locking Tool.

Valve Top-cap Connectors

These insulated anode connectors have been designed for use with high voltage rectifying valves. The metal part is completely enclosed in a red bakelite shroud.

Cat. No. 562 Medium size, to fit 9mm. top cap.

Cat. No. 563 Large size, to fit 9⁄16" top cap.

For prices see separate list.

COUPLERS, TOOLS, VALVE CAPS



550

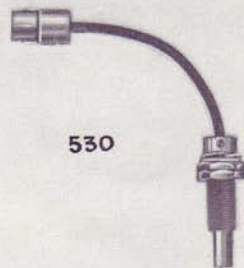

530



529



125T

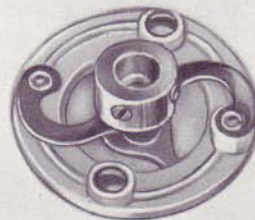

50



122T



563

MISCELLANEOUS ITEMS



649



535



1008

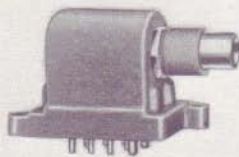

534



1007



708

Bakelite Tag Strip Cat. No. 649

1½" long, two 6 BA clearance fixing holes, five anchoring soldering tags.

Extension Control Outfit Cat. No. 1008

Resin-bonded insulating tube, 4" long, which cannot warp or bend. Brass rod is 3" long, ¼" diameter. Brass panel bush and locking nut.

Plug and Socket Connector

Useful in many applications. Two heavy duty pins (and sockets) for heavy currents and eight smaller pins for H.T., bias, etc. Either the plug or socket can be fitted to the screening cover, which is diecast and finished ripple grey. Insulation is DL9 bakelite. Screened cable easily attached.

Cat. No. 535 Ten-way Socket.

Cat. No. 534 Ten-way Plug with screening cover.

Cat. No. 549 Gland fittings to convert to double-entry.

Adjustable Insulated Bracket Cat. No. 1007

Insulated section, of DL9 bakelite, is adjustable for mounting centres from 2½" to 3½" above chassis. Hole is ⅜" clear. Metal part is steel, finished black, and with two fixing holes.

Metal Bracket Cat. No. 708

Slotted mounting bracket, for use where insulation is not necessary. Enables components to be fitted close to chassis. Height 2 ⅛". Length of slot 1 ⅜". Takes ⅜" bushes. Glossy black finish.

For prices see separate list.

145 Mc/s Beam Aerial Cat. No. 717

Four element beam array, with folded dipole radiator. The special terminating insulator takes B.I.C. coaxial cable type T.3024 or similar cable of 70/80 ohms impedance. Completely weatherproof when assembled according to the instructions supplied. Fixed spacing between elements but the latter are of adjustable length to suit frequency in use. Forward gain 10/11 db compared to simple dipole, front-to-back ratio approximately 20 db.

Mounting Plate Cat. No. 762

This mounting plate is intended for use with the Cat. No. 717 Beam Aerial Array when it is desired to rotate the aerial, electrically or manually. Holes are provided in the plate, which is mild steel durably finished, for bolting to a pulley or to the coupling of a motor-driven reduction unit. The tube attached to the plate accepts the stem of the aerial array and is keyed to prevent unrelated movement.

145 Mc/s Tuning Assembly Cat. No. 709

Main inductance loop of $\frac{1}{8}$ " copper clamped to the stators of a Cat. No. 739 condenser. Length in circuit is adjustable and tapping clip is provided. Hairpin coupling loop supported on ceramic strip. Whole is silver plated and lacquered and fitted to a Cat. No. 708 bracket. Alternative mountings possible. Can be used in receivers, transmitters, wavemeters, oscillators, etc.

" Tee " Insulators Cat. Nos. 766 and 767

For use as a terminating insulator at the centre of a dipole or folded dipole aerial. Except for the cable glands, the insulators are of identical size, the arms accepting $\frac{1}{4}$ " diameter tubing. Cat. No. 766 has a gland to take light solid coaxial cable (e.g. Uniradio 39) of overall diameter up to $\frac{3}{16}$ " (polythene core of cable $\frac{3}{16}$ " diameter). The Cat. No. 767 Insulator accepts heavier cable (e.g. Uniradio No. 1) of up to $15/32$ " overall diameter (polythene section $\frac{3}{16}$ " diameter).

For prices see separate list.

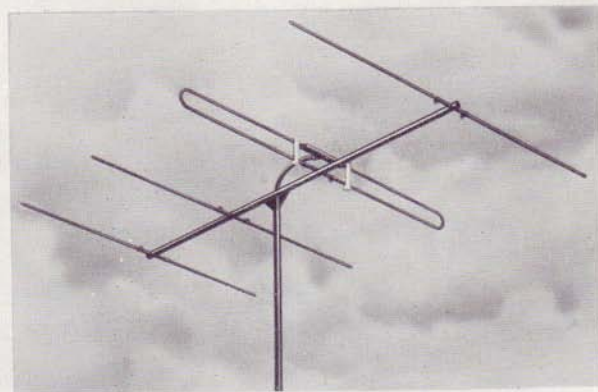
V.H.F. ITEMS

717

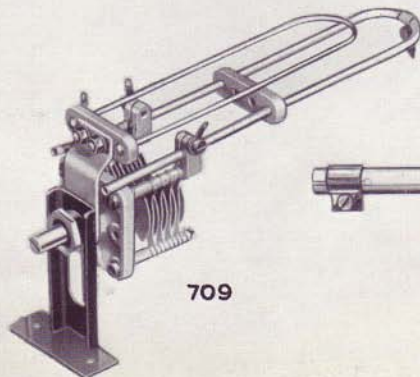

709

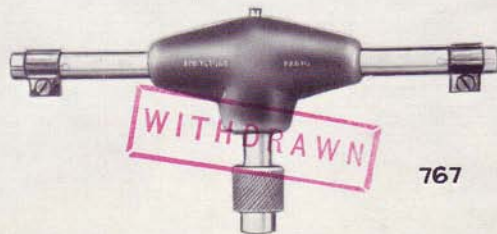

767

PRICE LIST OF
EDDYSTONE
COMPONENTS AND ACCESSORIES



STRATTON & CO., LTD.

EDDYSTONE WORKS

ALVECHURCH ROAD . WEST HEATH . BIRMINGHAM, 31

Telephone : Priory 2231/4

Telegrams : Stratnoid, Birmingham



Cat. No.	Description	List Price
		£ s. d.
1954 Eddystone Component Catalogue	...	1 0

ACCESSORIES.

669	"S" Meter	...	5 18 0
678	Modulation Meter...	...	10 6 6
687	Vibrator Power Unit (6 volt)	...	13 5 0
687/1	Vibrator Power Unit (6 volt)	...	13 16 6
688	Loudspeaker, Diecast (Black)	...	3 3 3
689	Morse Key (Semi-Automatic)	...	4 5 3
696/1	Wavemeter 220 Mc/s to 200 kc/s.	...	13 18 6
697	Loudspeaker, Diecast (Brown)	...	3 3 3
709	145 Mc/s. Tuning Assembly	...	1 1 6
717	145 Mc/s. Beam Aerial	...	4 16 3
762	Mounting Plate (for Cat. No. 717)	...	18 0
732	Mains Filter Unit	...	2 15 0
774	Receiver Mounting Blocks (Black)	per pair	11 6
811	Loudspeaker, Diecast (Polychromatic Grey)	...	3 3 3
812	Receiver Mounting Blocks (Polychromatic Grey)	per pair	11 6

TRANSMITTING AND NEUTRALISING CONDENSERS.

481	Midget Neutralising Condenser 1.5 to 4 pF	...	3 9
532	Single Section 150 pF	...	17 1 0
699	Neutralising Condenser 2 — 12 pF	...	1 11 9
756	Neutralising Condenser Disc type 8 to 1.5 pF...	...	9 6
815	Single Section 60 pF. One end plate 2" square...	...	16 0
816	Single Section 175 pF. One end plate 2" square	...	17 6
817	Single Section 250 pF. One end plate 2" square	...	1 0 0
831	Split Stator 25x25 pF. Two end plates 2½" sq.	...	1 9 0

Cat. No.	Description	List Price
		£ s. d.
Transmitting and Neutralising Condensers—cont.		
832	Split Stator 50x50 pF. Two end plates 2½" sq.	1 15 0
833	Split Stator 100x100 pF. Two end plates 2½" sq.	2 12 6
834	Differential 100x100 pF. Two end plates 2½" sq.	2 11 6
835	Single Section 230 pF. Two end plates 2½" sq.	1 15 0
836	Single Section 100 pF. Two end plates 2½" sq.	1 10 0

MICRODENSERS.

476	Split Stator 15 x 15 pF	...	8 0
580	Single Section 12.5 pF	...	7 0
581	Single Section 60 pF (screwdriver adjustment)	...	9 0
582	Single Section 60 pF	...	9 0
583	Split Stator 25 x 25 pF	...	8 3
584	Butterfly 34 x 34 pF	...	8 9
585	Single Section 100 pF	...	11 6
586	Single Section 140 pF	...	12 0
587	Butterfly 15 x 15 pF	...	10 0
588	Single Section 27.5 pF	...	8 0
589	Single Section 54 pF	...	9 0
719	Differential 25 x 25 pF	...	8 3
738	Single Section 100 pF	...	16 6
739	Butterfly 8 x 8 pF	...	10 0

MINIATURE MICRODENSERS.

551	Butterfly 25 x 25 pF, 90° rotation	...	13 6
552	Split Stator 25 x 25 pF, 180° rotation	...	13 9
553	Single Section 50 pF, 180° rotation	...	12 6

KNOBS, DIALS AND SCALES.

62	Pointer Knob and Dial	...	2 0
---------------	----------------------------------	----------------	----------------

Cat. No.	Description	List Price
Knobs, Dials and Scales—continued		£ s. d.
591	Instrument Knob 2½" diameter	2 3
592	Instrument Knob 1¾" diameter	1 6
593	Instrument Knob ¾" diameter	1 0
598	Full Vision Dial	1 4 6
784	Skirt Knob 3¼"	2 9
785	Instrument Knob 7⁄8" diameter	1 0
786	Skirt Knob 7⁄8" diameter	1 4
841	Pointer Knob 1½" long	10
842	Knob (841) and Dial (0-10 over 265°)	1 6
843	Slow Motion Dial 4" diameter	17 9
844	Knob and Dial 2" diameter	3 0
846	Bar Knob 1¾" long	3 6
872	Miniature Slow Motion Dial 1¾" diameter	16 6
875	Knob with skirt 1½" overall diameter	4 9
877	Wing Knob 1⅜" across rib	2 6
878	Miniature Skirt Knob ⅝" hole	1 3
1027	Pointer Knob 2⅞" long	1 0
1076	Instrument Knob 2½" diameter	3 6
1089	Instrument Knob 1⅜" diameter	1 9
2416P	Skirt Knob overall diameter 1¾"	1 9

COILS, FORMERS AND BASES.

537	Coil Former Plain (6 pin)	2 6
538	Coil Former Threaded (6 pin)	2 9
646	Former (ribbed 1")	1 6
647	Small Coil Former Plain	1 0
648	Small Coil Former Threaded	1 0
706/LB	4 pin Coil	6 6
706/Y	4 pin Coil	6 6

Cat. No.	Description	List Price
Coils, Formers and Bases—continued		£ s. d.
706/R	4 pin Coil	6 6
706/W	4 pin Coil	8 6
706/P	4 pin Coil	8 6
706/G	4 pin Coil	8 6
706/BR	4 pin Coil	8 6
775	Coil Stand (4 pin)	2 9
783	Coil Stand (2 pin)	2 9
707	4 pin Base (for 706 Coils)	2 6
763	4 pin Former Plain (as used on 706 Coils)	2 0
765	4 pin Former Threaded (as used on 706 Coils)	2 3
781	2 pin Coil Former	2 0
782	2 pin Coil Base	2 0
847	Polystyrene Former	2 6
864	Choke Former (2½")	8
865	Choke Former (1⅞")	6
866	Choke Former (1")	6
867	Choke Former (1")	4
964	6 pin Base	2 0
1090	Frequentite Former	8 6 10/6
1091	Frequentite Sub-Base	9 6
1092	Frequentite Base	8 0

R.F. CHOKES.

737	Choke 2.5 millihenries inductance	3 3
776	Choke 2.5 millihenries inductance	4 3
1010	Choke 1.25 millihenries inductance	2 3
1011	Choke 5.6 microhenries inductance	1 9
1022	Choke 1.5 millihenries inductance	3 6
1066	Choke 13 millihenries inductance	4 3

Cat. No.	Description	List Price
		£ s. d.
INSULATORS.		
564	Red Moulded Insulator	1 8
565	Black Moulded Insulator	1 8
695	Lead-Through Insulator	1 0
766	" Tee " Insulator	16 6
767	" Tee " Insulator	16 6
794	Lead-Through Insulator	6 6
916	Stand-off Insulator	1 6
946	Aerial Lead-in Insulator	3 9
966	Pyrex Insulator	1 6
1018	Ceramic Lead-Through Insulator	2 9
1019	Miniature Stand-off Insulator	7 9

RACK EQUIPMENT.

874	Three-way Equipment Rack (to take 3 x 873)	1 7 6
873	Complete Rack Mounting Cabinet Assembly ...	2 18 6
861	Spare Panel for Cabinet	7 3
862	Spare Chassis	8 6

CHASSIS, CABINETS, BOXES AND HANDLES.

643	Diecast Aluminium Chassis 8½" x 5½" x 2½" deep	12 6
644	Metal Cabinet 7" high	1 8 0
727	Diecast Aluminium Chassis 12" x 9" x 3" deep...	1 4 0
787	Cabinet	3 18 6
788	Chassis (for 787 Cabinet)	8 3
650	Diecast Box	7 2 8/-
608	Large Cabinet Handles, Chromium Plated, 7½"	8 3 10/6
635	Small Cabinet Handles, Chromium Plated, 3" ...	6 9

Cat. No.	Description	List Price
		£ s. d.
I.F. AND B.F.O. TRANSFORMERS.		
728	I.F. Transformer 10 Mc/s.	9 6
851	I.F. Transformer 455 kc/s.	7 6
852	B.F.O. Unit 455 kc/s.	6 6
853	I.F. Transformer 5.2 Mc/s.	7 6
854	Discriminator Transformer 5.2 Mc/s.	8 6
855	B.F.O. Unit 5.2 Mc/s.	6 6
856	I.F. Transformer 10.7 Mc/s.	7 6
857	Discriminator Transformer 10.7 Mc/s.	8 6

COUPLERS, SHAFTS AND BRACKETS.

50	Flexible Coupler Large	2 9
529	Flexible Coupler Medium	2 6
550	Flexible Coupler Small	2 6
530	Flexible Driving Shaft	7 6
708	Metal Bracket	1 4
1007	Adjustable Insulated Bracket	2 9
1008	Extension Control Outfit	3 6

MISCELLANEOUS.

122T	Metal Tipped Trimming Tool	1 8
125T	Valve Ring Locking Tool	1 4
534	Ten-way Plug with Cover	8 0
535	Ten-way Socket	5 0
549	Gland Fittings (for 534)	2 3
562	Small Valve Cap (9mm.)	1 4
563	Large Valve Cap (½")	1 4
649	5-way Tag Strip	1 0

Issued January, 1954.

Cancels all previous issues.